

- Notes:
1. Material: Polypropylene (PP)
 2. Weight: Approx 4 grams
 3. Thread: 6 TPI
 4. Omega Part # 7125

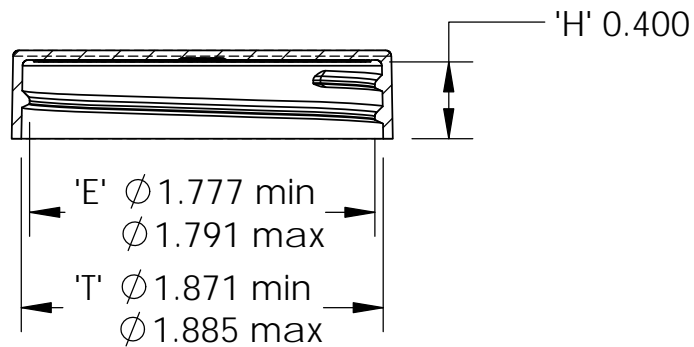

DIMENSION	TOLERANCE
.00	.015
.000	.010



15210 Desman Rd.
La Mirada, CA 90638
(714) 670-6400
omegapkg.com

PROPRIETARY AND CONFIDENTIAL
THE INFORMATION CONTAINED
IN THIS DRAWING IS THE SOLE
PROPERTY OF OMEGA PKG.
ANY REPRODUCTION IN PART OR
AS A WHOLE WITHOUT THE
WRITTEN PERMISSION OF OMEGA
PACKAGING IS PROHIBITED.

REVISION	DATE
LAST IR	DATE 7/18/2014

48mm Smooth
Cap

DWG. NO.	7125-48-Smooth	SCALE	1:1
----------	----------------	-------	-----